



# ***BRAD NAILERS***

Operating Instructions  
Instrucciones de Operacion  
Mode d'Emploi



***SHP10***



***FinishPro™ 25***

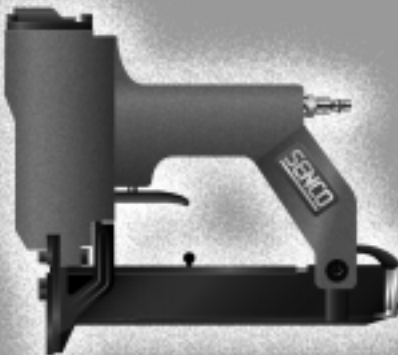

***LS***

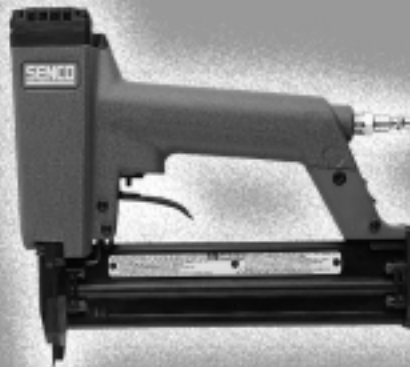

***SLP20***

Questions? Comments?

call SENCO's toll-free Action-line: 1-800-543-4596

or e-mail: [toolprof@senco.com](mailto:toolprof@senco.com) Visit our Website [www.senco.com](http://www.senco.com)



Senco Products, Inc.  
8485 Broadwell Road  
Cincinnati, Ohio 45244

© 2000, 2001 by Senco Products, Inc.



Warnings for the safe use of this tool are included in this manual.  
Los avisos para el uso seguro de esta herramienta están incluidos  
en este manual.

Les consignes pour l'utilisation en toute sécurité de cet outil se  
trouvent dans ce manuel.

BRNA070 Revised February 27, 2001  
(Replaces 9/14/00)

English	Espanol	Francais
---------	---------	----------

TABLE OF CONTENTS	TABLA DE MATERIAS	TABLE DES MATIERÈS	
Tool Use	1	Utilisation de l'outil	1
Maintenance	6	Entretien	6
Options	8	Options	8
Troubleshooting	8	Dépannage	8
Specifications	10	Spécifications	10
	Fallas		8
	Especificaciones		10

EMPLOYER'S RESPONSIBILITIES	RESPONSABILIDADES DEL EMPLEADOR	RESPONSABILITÉS DE L'EMPLOYEUR
Employer must enforce compliance with the safety warnings and all other instructions which accompany this tool as shipped from the manufacturer.	El empleador debe hacer cumplir las advertencias de seguridad y todas las otras instrucciones que acompañan a esta herramienta como se la despacha desde el fabricante.	L'employeur doit faire appliquer les consignes de sécurité et toutes les autres instructions qui accompagnent cet outil tel qu'il est livré par son constructeur.
Keep this manual available for use by all people assigned to the use of this tool.	Mantenga este manual disponible para que lo usen todas las personas destinadas a hacer uso de esta herramienta.	Ayez ce manuel à la disposition de toutes les personnes chargées d'utiliser cet outil.
For personal safety and proper operation of this tool, read and understand all of these instructions carefully.	Por razones de seguridad personal y la adecuada operación de esta herramienta, lea y comprenda todas estas instrucciones cuidadosamente.	Pour assurer la sécurité personnelle et le bon emploi de cet outil, lisez et assimilez soigneusement toutes ces instructions.

Tool Use	Uso de la Herramienta	Utilisation de l'Outil
----------	-----------------------	------------------------

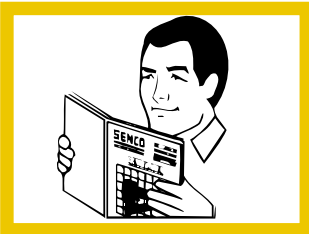

<ul style="list-style-type: none"> <li>● Read and understand "SAFETY INSTRUCTIONS" manual shipped with this tool before using tool.</li> </ul>	<ul style="list-style-type: none"> <li>● Antes de usar la herramienta lea y comprenda el manual "INSTRUCCIONES DE SEGURIDAD" despachado con ella.</li> </ul>	<ul style="list-style-type: none"> <li>● Lisez et assimilez le manuel "INSTRUCTIONS DE SÉCURITÉ" livré avec cet outil avant de l'utiliser.</li> </ul>
--	--	---

English

Espanol

Francais

LS1

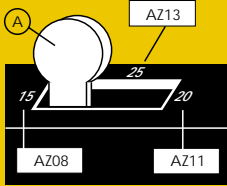

● Set magazine height adjustment lever (A) before loading fasteners.

● Coloque en posición correcta la palanca de ajuste de la altura del cargador antes de cargarlo con clavos.

● Positionnez le levier de réglage de hauteur du magasin avant chargement des projectiles.

LS2

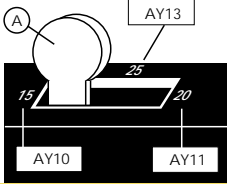

● Set magazine height adjustment lever (A) before loading fasteners.

● Coloque en posición correcta la palanca de ajuste de la altura del cargador antes de cargarlo con clavos.

● Positionnez le levier de réglage de hauteur du magasin avant chargement des projectiles.

LS5

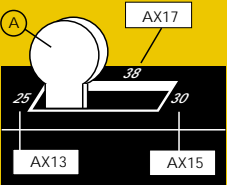

● Set magazine height adjustment lever (A) before loading fasteners.

● Coloque en posición correcta la palanca de ajuste de la altura del cargador antes de cargarlo con clavos.

● Positionnez le levier de réglage de hauteur du magasin avant chargement des projectiles.

SHP10

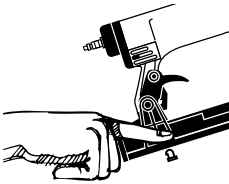

● Adjust magazine before loading. Remove magazine rail stop by pressing down on the top of the rail stop.

● Ajuste la carrillera antes de recargar. Remueva el tope del riel de la carrillera presionando la parte superior del tope del riel.

● Régler le magasin avant de le charger. Ôter l'arrêt de rail en pressant sur sa partie supérieure.

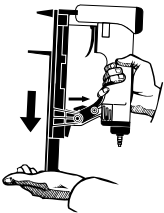

● Depress latch and remove magazine rail.

● Precione la palanca y remueva el riel de la carrillera.

● Actionner le verrou et ôter le rail.

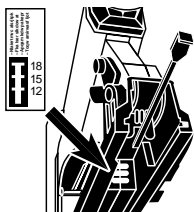

● Move the adjustment insert to the appropriate slot for the length of the fastener to be used.  
See Label: (12, 15, 18)  
12 = 12 mm or 1/2" Length  
15 = 15 mm or 5/8" Length  
18 = 18 mm or 3/4" Length

● Posicione la manivela en la longitud deseada del sujetador. Uea la etiqueta (12, 15, 18).  
12 = 12 mm o 1/2" longitud  
15 = 15 mm o 5/8" longitud  
18 = 18 mm o 3/4" longitud

● Bouger l'insert de réglage jusqu'à la position appropriée pour la longueur de projectiles choisie.  
Voir étiquette (12, 15, 18).  
12 = 12 mm ou 1/2" longueur  
15 = 15 mm ou 5/8" longueur  
18 = 18 mm ou 3/4" longueur

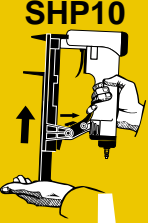
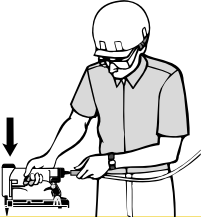
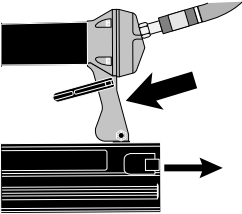
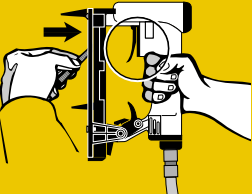
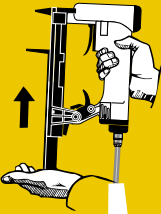
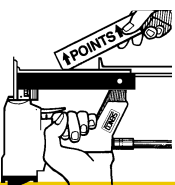
	Tool Use	Uso de la Herramienta	Utilisation de l'Outil
	English	Espanol	Francais
 <p><b>SHP10</b></p>	<ul style="list-style-type: none"> <li>● Depress latch and reinstall the magazine rail and magazine rail stop.</li> </ul>	<ul style="list-style-type: none"> <li>● Precione la palanca y reinstale el riel de la carrillera y el tope del riel de la carrillera.</li> </ul>	<ul style="list-style-type: none"> <li>● Actionner le verrou et remettre en place le rail ainsi que l'arrêt de rail.</li> </ul>
	<ul style="list-style-type: none"> <li>● Keep tool pointed away from yourself and others and connect air to tool.</li> </ul>	<ul style="list-style-type: none"> <li>● Mantenga la herramienta apuntando en dirección opuesta de usted y de otros y conecte el aire a la manguera.</li> </ul>	<ul style="list-style-type: none"> <li>● Maintenez l'outil pointé à l'écart d'autres personnes et de vous-même et raccordez l'air à l'outil.</li> </ul>
	<ul style="list-style-type: none"> <li>● To Load: Push latch and slide rail open. Use only genuine SENCO fasteners. Do not load with trigger depressed.</li> </ul>	<ul style="list-style-type: none"> <li>● Para Cargar: Empuje el cerrojo y deslice el carril abriéndolo. Use solamente sujetadores SENCO auténticos. No cargue con el gatillo oprimidos.</li> </ul>	<ul style="list-style-type: none"> <li>● Pour charger : Tirer le loquet et ouvrir le rail en le glissant. Utilisez uniquement des finettes d'origine SENCO. Veillez à ne pas appuyer sur la détente quand vous chargez.</li> </ul>
 <p><b>SHP10</b></p>	<ul style="list-style-type: none"> <li>● Lay strip of fasteners into magazine. Use only genuine SENCO fasteners. Do not load with trigger depressed.</li> </ul>	<ul style="list-style-type: none"> <li>● Coloque la tira de clavitos dentro del cargador. Use solamente sujetadores SENCO auténticos. No cargue con el gatillo oprimidos.</li> </ul>	<ul style="list-style-type: none"> <li>● Insérer la bande de finettes dans le magasin. Utilisez uniquement des finettes d'origine SENCO. Veillez à ne pas appuyer sur la détente quand vous chargez.</li> </ul>
	<ul style="list-style-type: none"> <li>● Push rail forward until it latches.</li> </ul>	<ul style="list-style-type: none"> <li>● Empuje el carril hacia adelante hasta cerrarlo.</li> </ul>	<ul style="list-style-type: none"> <li>● Pousser le rail jusqu'à encliquetage.</li> </ul>
 <p><b>SLP20 &amp; LS</b></p>	<ul style="list-style-type: none"> <li>● Place strip of fasteners into magazine with points facing direction shown. Direction of points on AZ headless pins is marked on side of strip. Use only genuine SENCO fasteners. Do not load with trigger depressed.</li> </ul>	<ul style="list-style-type: none"> <li>● Coloque la tira de clavitos en el cargador con las puntas viendo hacia la dirección que se muestra. La dirección de las puntas en los clavitos AZ sin cabeza esta marcada sobre el lado de las tiras. Use solo sujetadores SENCO genuinas. No cargue con el gatillo oprimidos.</li> </ul>	<ul style="list-style-type: none"> <li>● Insérer la bande de finettes dans le magasin avec les pointes dans la direction indiquée qui, pour les finettes sans tête (AZ), apparait sur le côté de la bande. Utilisez uniquement des finettes d'origine SENCO. Veillez à ne pas appuyer sur la détente quand vous chargez.</li> </ul>

## English

## Español

## Français

## SLP20 &amp; LS

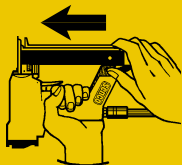

- Push rail forward until it latches.

- Empuje el carril hacia adelante hasta cerrarlo.

- Pousser le rail jusqu'a encliquetage.

## FinishPro™ 25

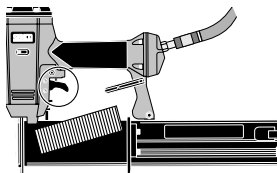

- To Load:  
Place strip of fasteners into magazine with points resting on fastener guide. Use only genuine SENCO fasteners. Do not load with safety element or trigger depressed.

- Para Cargar:  
Coloque la tira de clavillos dentro de la carrillera con la punta descansando sobre la guía. Use solo sujetadores SENCO genuinas. No cargue con el disparo o la seguridad oprimidos.

- Pour charger :  
Insérer la bande de projectiles dans le magasin en s'assurant que les pointes soient posées contre le guide inférieur. Utiliser uniquement des finettes d'origine SENCO. Vielles à ne pas appuyer sur la détente ou sur le palpeur de sécurité quand vous chargez.

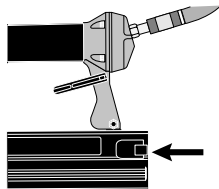

- Push rail forward until it latches.

- Empuje el carril hacia adelante hasta cerrarlo.

- Pousser le rail jusqu'a encliquetage.

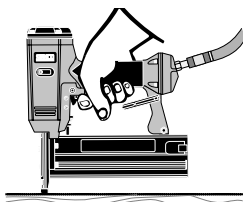

- Position safety element against work surface and pull the trigger.

- Oprima el seguro contra la superficie de trabajo y apriete el gatillo.

- Placez la sécurité contre la surface de travail et tirez sur la détente.

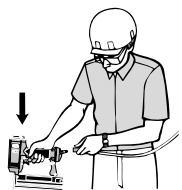

- The tool is equipped with an on-tool Power Adjustment system. This system will allow you to increase or decrease the power output without adjusting the air compressor. Disconnect tool from air supply before adjusting.

- La herramienta está equipada con un sistema de ajuste de potencia montado sobre ella. Este sistema le permite aumentar o disminuir la potencia sin ajustar el compresor de aire. Antes de ajustar la potencia desconecte la herramienta de la fuente de suministro de aire.

- L'outil possède un système intégré de réglage de puissance qui vous permet d'augmenter ou diminuer la puissance de sortie sans ajuster le compresseur pneumatique. Vous devez déconnecter l'alimentation en air de l'outil avant de régler la puissance.

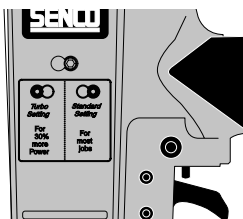

- The tool is pre-set at the factory using the Standard setting. Use this setting for most jobs (depending on the substrate). For a 30% increase in power, adjust the tool to the turbo setting using the Power Adjustment System - this can be done in 2 easy steps.

- La herramienta es preconfigurada en la fábrica utilizando la graduación "Standard" (estándar). Utilice esta graduación para la mayoría de los trabajos (en función del sustrato). Para incrementar la potencia en 30%, ajuste la herramienta a la graduación "Turbo" (turbina), utilizando el sistema de ajuste de potencia. Esto se puede efectuar en dos pasos sencillos.

- L'outil est pré-réglé en usine avec une puissance standard qui convient à la plupart des utilisations (selon le substrat). Pour augmenter la puissance de 30%, placez l'outil à la puissance Turbo, grace au système de réglage de puissance. Cet ajustement se fait en deux opérations simples.

English

Espanol

Francais

FinishPro™ 25

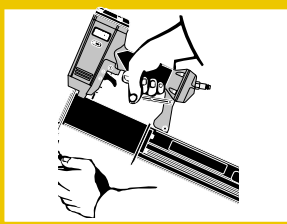
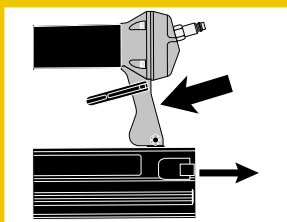
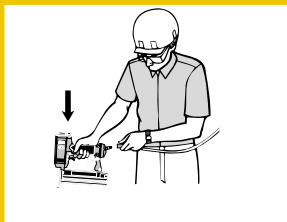
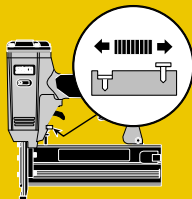
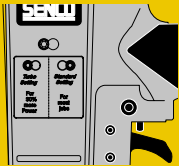

- 1.) Disconnect the air from the tool. **If the air is not removed from the tool, the adjustment cannot be made.**
- 2.) Using wrenches provided with the tool, insert in hole and move to the desired setting (forward - Turbo Setting) or (back - Standard Setting).

- To adjust the depth the fastener is driven, first disconnect the air supply. Using your thumb or index finger, rotate wheel to adjust the Depth Control safety element to achieve desired depth.

- Should a fastener jam occur, disconnect air supply.

- Push latch and slide rail open. Remove fasteners.

- Remove jammed fastener.

- 1.) Desconecte la alimentación de aire a la herramienta. **Si la alimentación de aire no se quita de la herramienta, no se puede efectuar el ajuste.**
- 2.) Con las llaves proporcionada con la herramientas, inserte la llave en el hueco y muevelo a su deseado marco.  
Para delante - Turbo  
(Para detras - normal)

- Para ajustar la profundidad de sujetador, dede primero desconectar el aire. Usando el dedo pulgar o el dedo indice, rote la manivela para ajustar el seguro a la profundidad deseada.

- Si se produce un atascamiento de las sujetadores desconecte el suministro de aire.

- Empuje el cerrojo y deslice el carril abriéndolo. Saque las sujetadores.

- Remueva el sujetador atascado.



- 1.) Déconnectez l'alimentation en air de l'outil. **Si vous n'enlevez pas l'alimentation en air de l'outil, vous ne pourrez pas en ajuster la puissance.**
- 2.) Utilisant les clefs fournis avec l'outil, introduisez-la dans le trou et reglez a la position desirée (en avant= turbo) (derrière = standard)



- Pour ajuster la profondeur à laquelle le projectile est enfoncé, déconnecter tout d'abord l'appareil de la source d'air comprimé. A l'aide du pouce ou de l'index, faire tourner la molette pour ajuster la position du palpeur de sécurité.

- Au cas ou un coincage de finettes se produirait, coupez l'arrivée d'air.

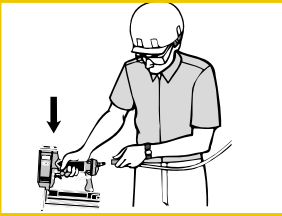
- Tirer le loquet et ouvrir le rail en le glissant. Enlever les projectiles.

- Enlevez le projectile coincé.

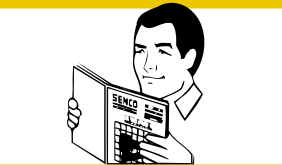
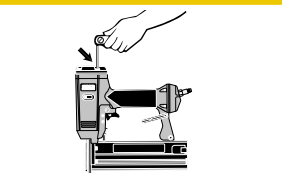
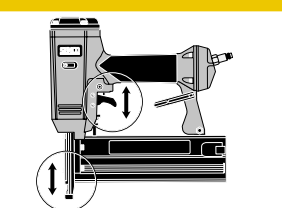
Tool Use      Uso de la Herramienta      Utilisation de l'Outil		
English	Espanol	Francais
 <p>● Keep the tool pointed away from yourself and others and connect air to tool.</p>	<p>● Mantenga la herramienta apuntada en la dirección opuesta de usted y de otros y conecte el aire a la manguera.</p>	<p>● Maintenez l'outil pointé à l'écart d'autres personnes et vous-même et raccordez l'air à l'outil.</p>
<p><b>FinishPro™ 25</b></p>  <p>● To adjust the direction of the exhaust air, turn the exhaust deflector to the desired location.</p>	<p>● Para ajustar la dirección del escape de aire, de le vueltas al deflector de aire al localización preferido.</p>	<p>● Pour changer la direction de l'échappement d'air, faire pivoter le déflecteur jusqu'à la position souhaitée.</p>

Maintenance      Mantenimiento      Entretien		
English	Espanol	Francais
 <p>● Read and understand "SAFETY INSTRUCTIONS" manual shipped with this tool before using tool.</p>	<p>● Antes de usar la herramienta lea y comprenda el manual "INSTRUCCIONES DE SEGURIDAD" despachado con ella.</p>	<p>● Lisez et assimilez le manuel "INSTRUCTIONS DE SÉCURITÉ" livré avec cet outil avant de l'utiliser.</p>
 <p>● All screws should be kept tight. Loose screws result in unsafe operation and parts breakage.</p>	<p>● Todos los tornillos tienen que mantenerse apretados. Los tornillos sueltos pueden producir una operación no segura y quebraduras de partes.</p>	<p>● Toutes les vis doivent être maintenues serrées à fond. Les vis desserrées entraînent un manque de sûreté du fonctionnement et la rupture de pièces.</p>
 <p>● With tool disconnected, make daily inspection to assure free movement of safety element and trigger. Do not use tool if safety element or trigger sticks or binds.</p>	<p>● Con la herramienta desconectada, haga inspecciones diarias para asegurar el movimiento libre del seguro y del gatillo. No use la herramienta si el seguro o el gatillo se atoran.</p>	<p>● L'outil étant séparé de l'alimentation en air, effectuez une inspection journalière pour assurer le libre mouvement du palpeur de sécurité et de la détente. N'utilisez pas l'outil si le palpeur de sécurité ou la détente colle ou se coince.</p>
<p><b>SLP20 &amp; FinishPro™25</b></p>  <p>● Routine lubrication is not necessary. Do not oil.</p>	<p>● La lubricación de rutina no es necesaria. No aceite.</p>	<p>● La lubrification de routine n'est pas nécessaire. N'huilez pas.</p>

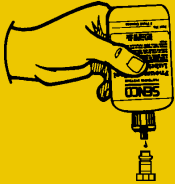
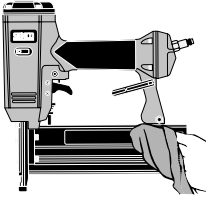
Maintenance	Mantenimiento	Entretien
English	Espanol	Francais
 <p><b>SHP10 &amp; LS</b></p> <ul style="list-style-type: none"> <li>● Squirt Senco pneumatic oil (5 to 10 drops) into the air inlet twice daily (depending on frequency of tool use). Other oils may damage O-rings and other tool parts.</li> </ul>	<ul style="list-style-type: none"> <li>● Aplique aceite neumático SENCO en la entrada de aire dos veces al día (dependiendo en la frecuencia de uso 5 A 10 Gotas). Otros aceites pueden dañar los anillos en "O" y otras piezas de la herramienta.</li> </ul>	<ul style="list-style-type: none"> <li>● Avec une burette, placer 5 à 10 gouttes d'huile pneumatique dans l'arrivée d'air deux fois par jour (dépend de l'intensité de l'utilisation de l'appareil). D'autres huiles pourraient endommager les joints toriques et d'autres pièces de l'outil.</li> </ul>
 <ul style="list-style-type: none"> <li>● Wipe tool clean daily and inspect for wear. Use non-flammable cleaning solutions only if necessary—DO NOT SOAK. <b>Caution:</b> Such solutions may damage O-rings and other tool parts.</li> </ul>	<ul style="list-style-type: none"> <li>● Solamente si es necesario use soluciones para limpieza no inflamables -NO LA REMOJE. Precaución: Tales soluciones pueden dañar los empaques y otras partes de la herramienta.</li> </ul>	<ul style="list-style-type: none"> <li>● Nettoyez l'outil chaque jour à l'aide d'un chiffon et inspectez-le pour déceler une éventuelle usure. Utilisez uniquement des solvants non inflammables en cas de nécessité-NE LE FAITES PAS TREMPER ! <b>Attention :</b> De tels produits peuvent endommager les joints et autres pièces de l'appareil.</li> </ul>

Accessories	Accesorios	Accessoires
English	Espanol	Francais
<p>SENCO offers a full line of accessories for your SENCO tools, including:</p> <ul style="list-style-type: none"> <li>● Air Compressors</li> <li>● Hose</li> <li>● Couplers</li> <li>● Fittings</li> <li>● Safety Glasses</li> <li>● Pressure Gauges</li> <li>● Lubricants</li> <li>● Regulators</li> <li>● Filters</li> </ul> <p>For more information or a complete illustrated catalogue of SENCO accessories, ask your representative for #DLD118.</p>	<p>SENCO ofrece una línea completa de Accesorios para sus herramientas SENCO, incluyendo:</p> <ul style="list-style-type: none"> <li>● Compresores de Aire</li> <li>● Manguera</li> <li>● Conectores Rápidos</li> <li>● Conectores</li> <li>● Anteojos De Seguridad</li> <li>● Manómetros</li> <li>● Lubricantes</li> <li>● Reguladores</li> <li>● Filtros</li> </ul> <p>Para mas informacion ó un pour recevoir un catalogo completo ilustrado de los Accesorios SENCO, pregunte a su representante pour el numero DLD118.</p>	<p>SENCO offre une gamme étendue d'accessoires pour vos outils SENCO y compris :</p> <ul style="list-style-type: none"> <li>● Compresseurs</li> <li>● Tuyauterie flexible</li> <li>● Raccords</li> <li>● Lunettes de sécurité</li> <li>● Manomètres</li> <li>● Lubrifiants</li> <li>● Régulateurs</li> <li>● Filtres</li> </ul> <p>Pour plus d'informations ou pour recevoir un catalogue détaillé des accessoires proposés par SENCO, prenez contact avec votre représentant SENCO (référence catalogue : #DLD118).</p>

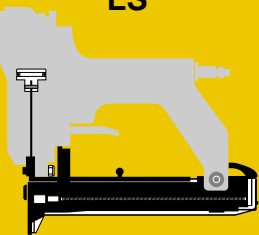
Options	Opciones	Options
English	Espanol	Francais
 <p><b>LS</b></p> <ul style="list-style-type: none"> <li>● LS Tools can be converted to use different size fasteners with these complete kits.</li> </ul>	<ul style="list-style-type: none"> <li>● Las LS herramienta pueden ser convertidas para usar clavos de diferentes medidas con estos conjuntos completos.</li> </ul>	<ul style="list-style-type: none"> <li>● Les appareils LS peuvent être modifiés de façon à utiliser des projectiles de taille différente grâce à ce kit complet.</li> </ul>
<b>LS1 GA0238</b>	<b>LS2 GA0239</b>	<b>LS4 GA0298</b>
		<b>LS5 GA0320</b>



English

Espanol

Francais

SLP20

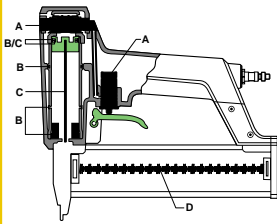

**WARNING**  
Repairs other than those described here should be performed only by trained, qualified personnel. Contact SENCO for information at 1-800-543-4596.

- Read and understand "SAFETY INSTRUCTIONS" manual shipped with this tool before using tool.

**ALERTA**  
Las reparaciones, fuera de aquellas descritas aquí, deben de ser llevadas a cabo solamente por personal entrenado y calificado. Póngase en contacto con SENCO para información 1-800-543-4596.

- Antes de usar la herramienta lea y comprenda el manual "INSTRUCCIONES DE SEGURIDAD" despachado con ella.

**AVERTISSEMENT**  
Les réparations autres que celles décrites ici doivent être réalisées uniquement par du personnel qualifié ayant reçu la formation appropriée. Pour toute information, prenez contact avec SENCO par téléphone en appelant Le Distributeur agréé.

- Lisez et assimilez le manuel "INSTRUCTIONS DE SÉCURITÉ" livré avec cet outil avant de l'utiliser.

FinishPro™25

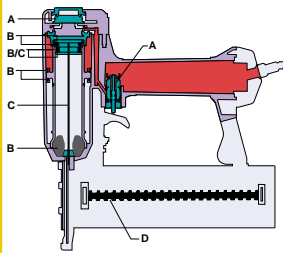

**SYMPTOM**  
Air leak near top of tool / Sluggish operation

**SOLUTION**  
Verify air supply / tighten screws or install Parts Kit A.

**SÍNTOMA**  
El aire se escapa cerca de la parte superior de la herramienta / Operación lenta.

**SOLUCIÓN**  
Apriete los tornillos / Verifique el suministro de aire o instale el Juego de Partes A (Parts Kit A).

**SYMPTÔME**  
Fuite d'air près du sommet de l'outil / fonctionnement lent.

**SOLUTION**  
Serrez les vis à fond / vérifiez l'alimentation en air ou remplacez les pièces portant la lettre "A".

**SYMPTOM**  
Air leak near bottom of tool / Poor return.

**SOLUTION**  
Clean tool / tighten screws or install Parts Kit B.

**SÍNTOMA**  
El aire se fuga cerca de la parte inferior de la herramienta / Mal retorno.

**SOLUCIÓN**  
Apriete los tornillos / Limpié la herramienta o instale el Juego de Partes B (Parts Kit B).

**SYMPTÔME**  
Fuite d'air près de la base de l'outil / retour inadéquat.

**SOLUTION**  
Serrez les vis à fond / nettoyez l'outil ou remplacez les pièces portant la lettre "B"

SHP10

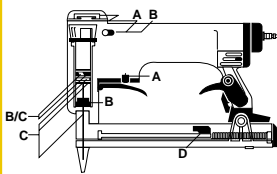

**SYMPTOM**  
Broken or worn driver / Weak drive.

**SOLUTION**  
Verify adequate air supply or install Parts Kit C.

**SÍNTOMA**  
Impulsor quebrado o desgastado / Impulsión débil.

**SOLUCIÓN**  
Verifique si el suministro de aire está adecuado o instale el Juego de Partes C (Parts Kit C).

**SYMPTÔME**  
Couteau cassé ou usé / entraînement déficient.

**SOLUTION**  
Vérifiez l'alimentation en air adéquate ou / remplacez les pièces portant la lettre "C".

**SYMPTOM**  
Poor feed / Tool jamming.

**SOLUTION**  
Clean tool or lubricate magazine or install Parts Kit D.

**SÍNTOMA**  
Mala alimentación / Atascamiento de la herramienta.

**SOLUCIÓN**  
Limpié la herramienta o lubrique el área de almacenamiento o instale el Juego de Partes D (Parts Kit D).

**SYMPTÔME**  
Enrayage de l'outil / alimentation inadéquat.

**SOLUTION**  
Nettoyez l'outil ou lubrifiez le magasin ou remplacez les pièces portant la lettre "D"

LS

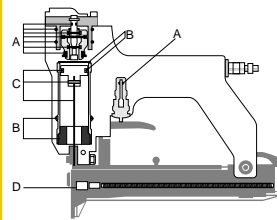

**SYMPTOM**  
Other problems.

**SOLUTION**  
Contact SENCO.

**SÍNTOMA**  
Otros problemas.

**SOLUCIÓN**  
Póngase en contacto con SENCO.

**SYMPTÔME**  
Autres problèmes.

**SOLUTION**  
Prenez contact avec SENCO.

**Specifications**

**Especificaciones**

**Specifications**

**English**

**Espanol**

**Francais**

**TECHNICAL SPECIFICATIONS**

	SLP20		FinishPro™ 25		SHP10		LS	
Minimum to maximum operating pressure	70–120 psi	4.8–8.3 bar	70–120 psi	4.8–8.3 bar	75–100 psi	5.2–7 bar	80–110 psi	5.5–7.5 bar
Air Consumption (60 cycles per second)	1.92 scfm	52.7 liter	1.92 scfm	52.7 liter	0.76 scfm	21.6 liter	.82 scfm	23.1 liter
Air Inlet	¼ in. NPT	¼ in. NPT	¼ in. NPT	¼ in. NPT	¼ in. NPT	¼ in. NPT	¼ in. NPT	¼ in. NPT
Maximum Speed (60 cycles per second)	5	5	5	5	8	8	5	5
Weight	2.3 lbs.	1 kg	2.7 lbs.	1.2 kg	2.4 lbs.	1.1 kg	2.7 lbs.	1.2 kg
Fastener Capacity	110	110	110	110	200	200	100	100
Tool size: Height	8 ¼ in.	210 mm	9 ⅞ in.	251 mm	5 ⅞ in.	148 mm	7 ¾ in.	197 mm
Tool size: Length	9 ½ in.	241 mm	9 ⅜ in.	249 mm	8 ⅝ in.	218 mm	8 ⅝ in.	211 mm
Tool size: Width: Main Body	2 in.	50 mm	2.2 in.	56 mm	1 ½ in.	41 mm	2 in.	51 mm

**ESPECIFICACIONES TECNICAS**

	SLP20		FinishPro™ 25		SHP10		LS	
Presión de operación mínima y máxima	70–120 psi	4.8–8.3 bar	70–120 psi	4.8–8.3 bar	75–100 psi	5.2–7 bar	80–110 psi	5.5–7.5 bar
Consumo de aire (60 ciclos por segundo)	1.92 scfm	52.7 liter	1.92 scfm	52.7 liter	0.76 scfm	21.6 liter	.82 scfm	23.1 liter
Entrada de aire	¼ in. NPT	¼ in. NPT	¼ in. NPT	¼ in. NPT	¼ in. NPT	¼ in. NPT	¼ in. NPT	¼ in. NPT
Velocidad máxima (ciclos por segundo)	5	5	5	5	8	8	5	5
Peso	2.3 lbs.	1 kg	2.7 lbs.	1.2 kg	2.4 lbs.	1.1 kg	2.7 lbs.	1.2 kg
Capacidad de grapas por cargador	110	110	110	110	200	200	100	100
Tamaño de la herramienta: Altura	8 ¼ in.	210 mm	9 ⅞ in.	251 mm	5 ⅞ in.	148 mm	7 ¾ in.	197 mm
Tamaño de la herramienta: Longitud	9 ½ in.	241 mm	9 ⅜ in.	249 mm	8 ⅝ in.	218 mm	8 ⅝ in.	211 mm
Tamaño de la herramienta: Ancho (Cuerpo)	2 in.	50 mm	2.2 in.	56 mm	1 ½ in.	41 mm	2 in.	51 mm

**SPECIFICATIONS TECHNIQUES**

	SLP20	FinishPro™ 25	SHP10	LS
Pression de travail min. et max.	4.8–8.3 bar	4.8–8.3 bar	5.2–7 bar	5.5–7.5 bar
Consommation d'air (60 cycles par seconde)	52.7 liter	52.7 liter	21.6 liter	23.1 liter
Admission d'air	¼ in. NPT	¼ in. NPT	¼ in. NPT	¼ in. NPT
Vitesse maximum (cycles par seconde)	5	5	8	5
Poids	1 kg	1.2 kg	1.1 kg	1.2 kg
Capacité de projectiles par magasin	110	110	200	100
Dimensions de l'outil: hauteur	210 mm	251 mm	148 mm	197 mm
Dimensions de l'outil: longueur	241 mm	249 mm	218 mm	211 mm
Dimensions de l'outil: largeur: corps de l'appareil)	50 mm	56 mm	41 mm	51 mm

**SLP20**

**MODEL: 430001N**

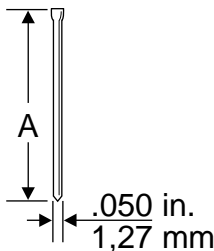

Code	A	
	Inches	mm
AY10	¾	16
AY11	¾	19
AY12	1	25

**MODEL: 430001N**

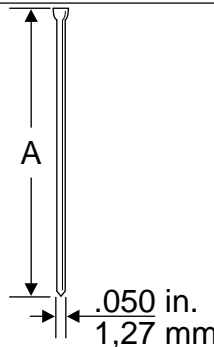

Code	A	
	Inches	mm
AX13	1	25
AX15	1 ¼	32
AX17	1 ½	38
AX18	1 ⅝	41

**Specifications**

**Especificaciones**

**Specifications**

**English**

**Espanol**

**Francais**

**FinishPro™25**

**MODEL: 760002N**

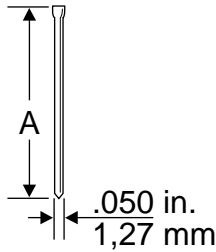

Code	A	
	Inches	mm
AY10	5/8	16
AY11	3/4	19
AY13	1	25
AY15	1 1/4	32
AY17	1 1/2	38
AY18	1 5/8	41

**MODEL: 760002N**

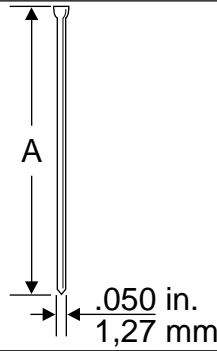

Code	A	
	Inches	mm
AX10	5/8	16
AX11	3/4	19
AX13	1	25
AX15	1 1/4	32
AX35	1 3/8	35
AX17	1 1/2	38
AX18	1 5/8	41
AX40	1 37/64	40
AX45	1 3/4	45
AX50	2	50
AX55	2 3/16	55

**MODEL: 760002N**

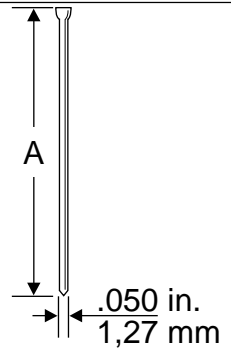

Code	A	
	Inches	mm
AXJ15	1 1/4	32
AXJ17	1 1/2	38
AXJ18	1 5/8	41
AXJ21	2	50
AXJ35	1 3/8	35
AXJ40	1 5/8	40
AXJ45	1 3/4	45
AXJ50	2	50
AXJ55	2 3/16	55

**LS**

**MODEL: 200001N (LS1)**

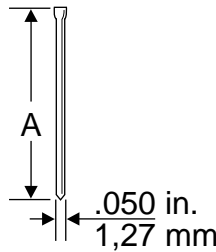

Code	A	
	Inches	mm
AZ08	1/2	13
AZ11	3/4	19
AZ13	1	25

**MODEL: 200001N (LS2)**

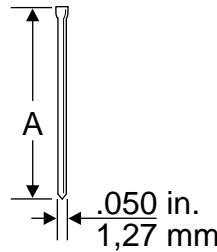

Code	A	
	Inches	mm
AY10	5/8	16
AY11	3/4	19
AY13	1	25

**MODEL: 200001N (LS5)**

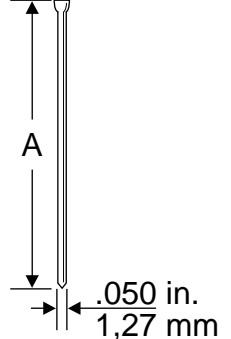

Code	A	
	Inches	mm
AX13	1	25
AX15	1 1/4	32
AX17	1 1/2	38

**SHP10**

**MODEL: 200001N (LS1)**

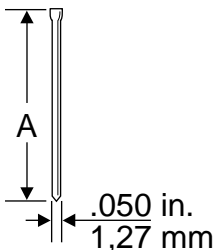

Code (Europe)	A	
	Inches	mm
CZ08 (JS12)	1/2	12
CZ10 (JS15)	5/8	15
CZ11 (JS18)	3/4	18

## **SENCO TOOL & PARTS WARRANTY**

**This tool has been designed and constructed using the highest standards of material and workmanship.**

### **TOOL AND PARTS WARRANTY:**

The length of this guarantee is **one year** from date of purchase by the **original retail purchaser**. During this period, Senco Products, Inc., will repair or replace at Senco's option, any original part or parts for the original retail purchaser. This will be done free of charge, provided the parts are determined defective in materials or workmanship upon examination by a Senco Authorized Warranty Service Center (exception: rubber o-rings and seals, driver blades). Any replacement part provided will carry a warranty for the balance of the period of warranty applicable to the part it replaces.

This warranty will be honored, only if:

- A) Clean, dry, regulated compressed air has been used, at air pressure not exceeding the maximum indicated on the tool casting;
- B) No evidence of abuse, or failure to follow recommended operational maintenance, or modification of the tool is present (read Operator Manual for use and maintenance instructions);
- C) When repair or replacement of parts or tools is necessary, the original retail purchaser returns the complete tool or part, with transportation prepaid, to the nearest Senco Authorized Warranty Service Center, with purchase receipt or other positive proof that the part or tool is within the warranty period.

THIS WARRANTY IS THE ONLY WARRANTY ON THIS TOOL, AND ALL OTHER WARRANTIES, WHETHER ORAL, WRITTEN, EXPRESS, OR IMPLIED, INCLUDING, BUT NOT LIMITED TO, THE IMPLIED WARRANTY OF MERCHANTABILITY OR PARTICULAR PURPOSE, ARE EXCLUDED. BUYER'S OR USER'S REMEDIES ARE SOLELY AND EXCLUSIVELY AS STATED ABOVE. Senco PRODUCTS, INC. SHALL IN NO EVENT BE LIABLE FOR INCIDENTAL, CONSEQUENTIAL, INDIRECT, OR SPECIAL DAMAGES. IN NO EVENT, WHETHER AS A RESULT OF A BREACH OF CONTRACT, WARRANTY, TORT (INCLUDING NEGLIGENCE) OR OTHERWISE, SHALL Senco'S LIABILITY EXCEED THE PRICE OF THE TOOL WHICH HAS GIVEN RISE TO THE CLAIM OR LIABILITY. ANY LIABILITY CONNECTED WITH THE USE OF THIS TOOL SHALL TERMINATE UPON THE EXPIRATION OF THE WARRANTY PERIOD SPECIFIED ABOVE.

### **Replacement of Tool Due to Natural Disaster**

Senco will also replace any tool destroyed by an Act of God such as flood, earthquake, hurricane or other disaster resulting only from the forces of nature. Such a claim will be honored provided that such original retail purchaser had previously submitted a completed warranty registration card, and then submits proof of ownership and an acceptable statement describing such Act of God documented by an insurance carrier, police department, or other official governmental source. To obtain instructions for filing a claim call 1-800-543-4596.

**SENCO PRODUCTS, INC.  
CINCINNATI, OHIO 45244-1611 USA**